

Model No. 9 was sold from August 1920 to August 1922

ALADDIN®

MODEL NO. 9 EXPLODED VIEW PARTS LIST

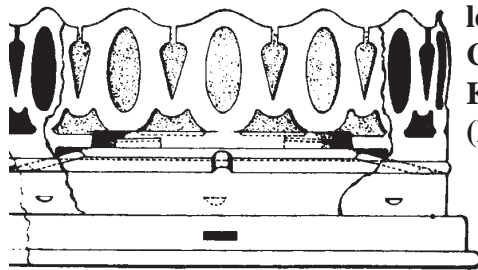

No. 9 Oil Lamp Gallery holds Heel-less Chimney and Kone Kap Mantle (No longer available)

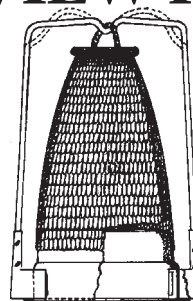

N146 Kone Kap Mantle fits Models 3 thru 11.



R111 Wick Trimmer cleans all Aladdin one inch wicks.

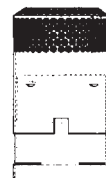

No. 9 Flame Spreader (No longer available)



No. 9 Outer Wick Tube (No longer available)

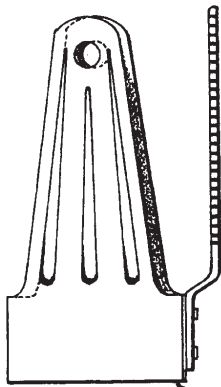
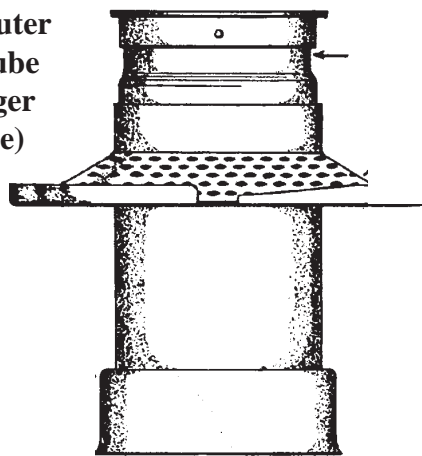

No. 9 Wick Raiser (No longer Available)

N198 Aladdin One Inch Cotton Wick fits Models 7 thru 11.

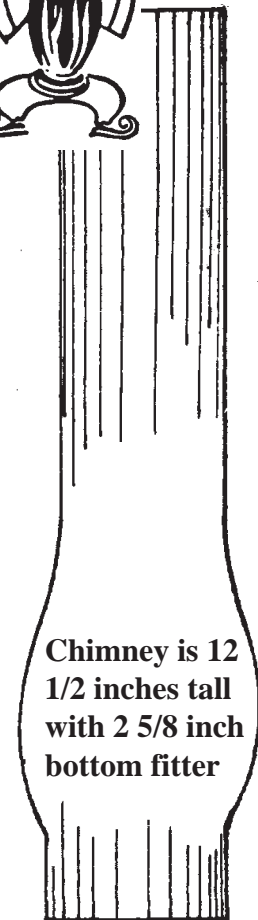

Chimney is 12 1/2 inches tall with 2 5/8 inch bottom fitter

Burner Inner Wick Tube

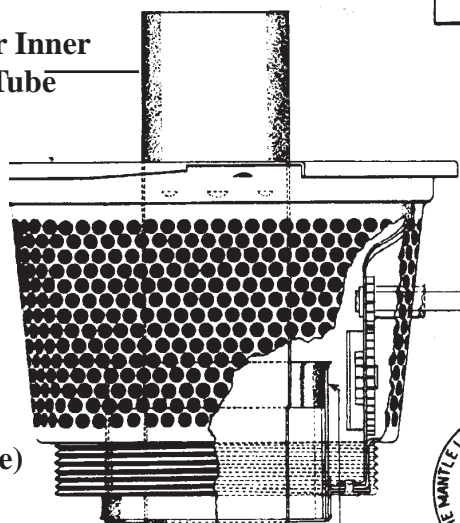

No. 9 Burner Base (No longer available)

Wick Raiser Knob

Face of No. 9 Burner Knob. Note: when ordering parts for your Aladdin lamp, always provide Model number.



Inner Wick Tube fits into bottom of burner

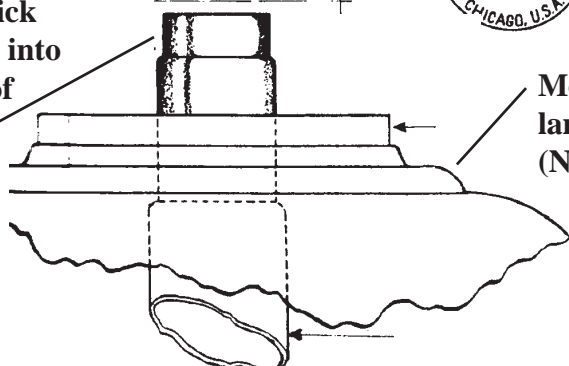

Model No. 9 lamp fount (No longer available)

Lighting The World, Since 1908

Aladdin Mantle Lamp Company
681 International Blvd.
Clarksville, TN 37040, USA
Tel: 800-457-5267 FAX: 931-647-4517
www.aladdinlamps.com
E-mail: sales@aladdinlamps.com